

# Table of Contents



## Description

1. Technical Specifications	1
2. Identification Data	3
3. Location of Parts	5
4. Steering cum Ignition lock	8
5. Fuel Tank Cap / Fuel Tap	9
6. Speedometer Details	10
7. Speedometer Setting	12
8. Control Switches	14
9. Rear seat / Tool kit	16
10. Front Seat / Battery	17
11. Fitment of Front & Rear Seat	18
12. Removal & Fitment of Side Cover LH & RH	19
13. Daily Safety Checks	20
14. How to ride your Bike	21
15. Safe Riding Tips	25
16. Engine Oil	26
17. Wheels - Tube less Tyre	27
18. Battery	28
19. Engine Cooling System / Coolant	29
20. Periodic Maintenance Information	30
21. Brake Fluid	32
22. Periodic Maintenance & Lubrication Chart	33
23. Non Use Maintenance	

## Safety and Warning information :



**Warning :** This indicates that a potential hazard or injury to you or other persons & to the vehicle can happen, if advice provided is not followed.



**Caution :** This indicates that a potential hazard which could result in vehicle damage, if advice provided is not followed.

## Notice:

The description and illustration in this booklet are not to be taken as binding on the manufacturers. The essential features of the type described and illustrated herein remaining unaltered. Bajaj Auto Limited reserves the right to carry out at any moment without being obliged to bring this booklet upto-date & to do modifications on the vehicle, parts or accessories as may be convenient and necessary.

## Technical Specifications



Engine	: 4 Stroke, Single Cyl.
Bore x Stroke	: 72.0 mm x 49.0 mm
Engine Displacement	: 199.5 cc
Compression Ratio	: 11 : 1
Idling Speed	: 1350 ~ 1450 RPM
Max. Net Power	: 23.5 PS at 9500 RPM
Max. Net Torque	: 18.3 Nm at 8000 RPM
Ignition System	: DC
Spark Plug	: 3 Nos
Spark Plug Gap	: 0.7 ~ 0.8 mm
Transmission	: 6 speed constant mesh
Gear Shifting Pattern	: 1 Down 5 Up
Engine Lubrication	: Pressurized oil supply
Engine Cooling	: Liquid cooling
Starting Aid	: Electric starter
Front Brake	: Hydraulic Disc type
Rear Brake	: Hydraulic Disc type

Fuel Tank Capacity	
Full	: 12 liters
Usable Reserve	: 2.4 liters
Unusable Reserve	: 0.2 liters
Dimensions	: <b>Pulsar NS</b> <b>Pulsar AS</b>
Length	: 2017 mm 2070 mm
Width	: 804 mm 804 mm
Height	: 1195 mm 1205 mm
Wheel base	: 1363 mm 1363 mm
Ground clearance	: 167 mm 167 mm
Tyre Size	
Front	: 100/80-17,52P tubeless
Rear	: 130/70-17,61P tubeless
Tyre Pressure	
Front	: 1.75 kgf/cm <sup>2</sup> (25 PSI)
Rear (Solo)	: 2.00 kgf/cm <sup>2</sup> (28 PSI)
Rear (with pillion)	: 2.25 kgf/cm <sup>2</sup> (32 PSI)

## Technical Specifications



Electrical System	: 12 Volts DC
Head Lamp	: H4, 55/60W
Position Lamp	: 3W (2 nos.)
Tail /Stop Lamp	: LED type
Side Indicator lamp	: 10W
Neutral Indicator	: Green LED
Hi Beam Indicator	: Blue LED
Turn Signal Indicator	: Green LED
Side Stand Indicator	: LED
Speedometer Lamp	: LED
Rear No. Plate Lamp	: 3W
Horn	: 12V DC
Battery	: 12V - 8 Ah VRLA
Vehicle Kerb Weight	: 145 kg.(For NS 200) 153 Kg.(For AS 200)
Gross Vehicle Weight	: 275 kg. (For NS 200) 283 kg. (For AS 200) (Including rider & pillion)
Max. Speed	: 136 km/hr.

### Note :

- All dimensions are under **UNLADEN** condition.
- Above information is subject to change without any notice.

## Identification Data



AS 200

The Frame and Engine serial numbers are used to register the motorcycle. They are the unique alpha-numeric codes to identify your particular vehicle from others of the same model and type.

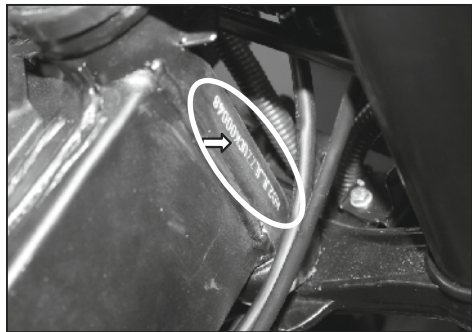

### Frame Number Location (For NS 200)

- ★ On RH Side of Steering Tube  
(Alpha-Numeric - 17 Digits)
- ★ On LH Side of Steering Tube  
(Alpha-Numeric - 17 Digits)  
[for applicable countries]

### Engine Number Location

On LH Side Crankcase Near Gear  
Change Lever (Alpha-Numeric - 11 Digits)

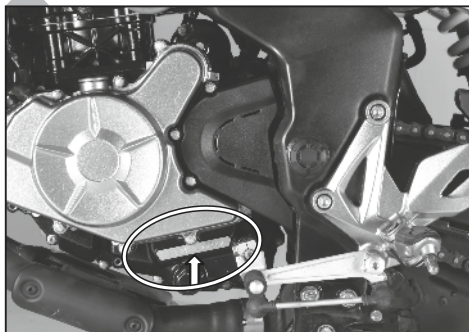

## Identification Data



AS 200

The Frame and Engine serial numbers are used to register the motorcycle. They are the unique alpha-numeric codes to identify your particular vehicle from others of the same model and type.

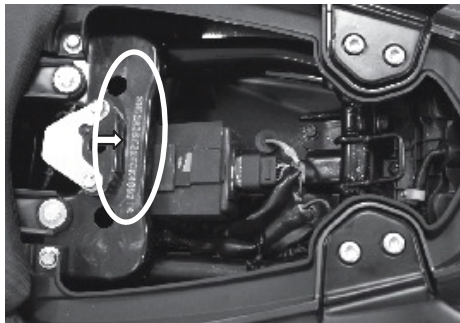

### Frame Number Location ( For AS200)

Below Pillion Seat  
(Alpha-Numeric - 17 Digits)

### Engine Number Location

On LH Side Crankcase Near Gear  
Change Lever (Alpha-Numeric - 11 Digits)

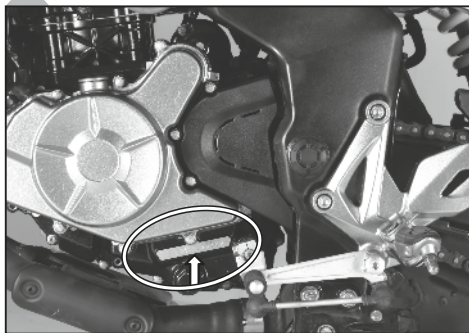

## Location of Parts (Pulsar NS 200)



AS 200

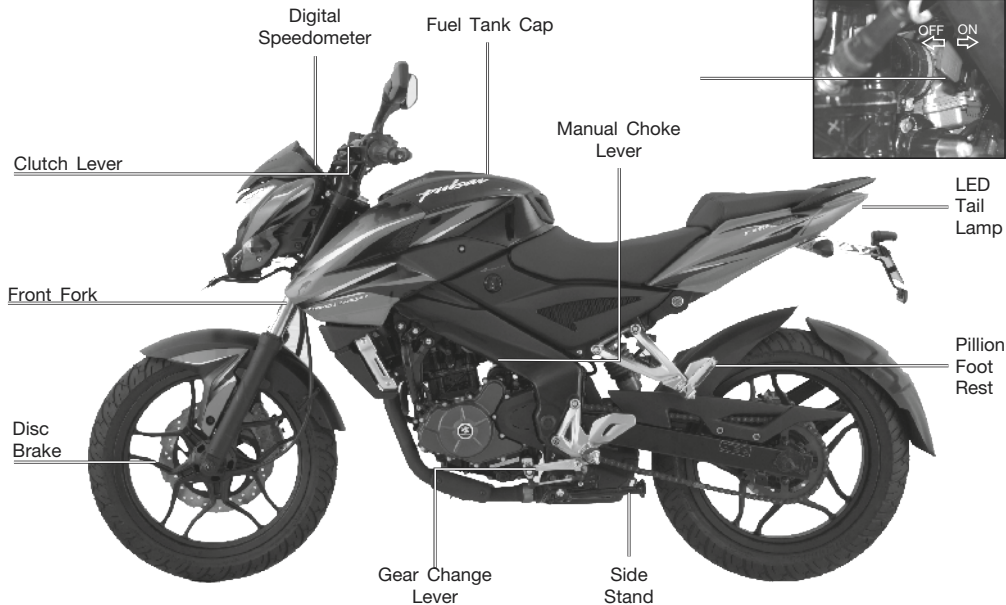

## Location of Parts ( Pulsar NS 200)



AS 200

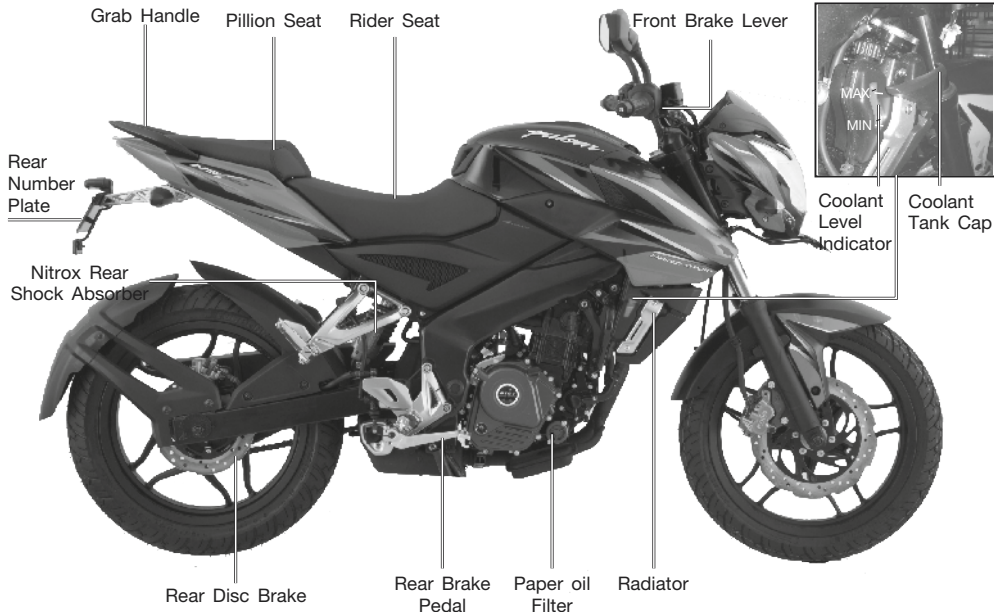

## Location of Parts (Pulsar AS 200)



AS 200

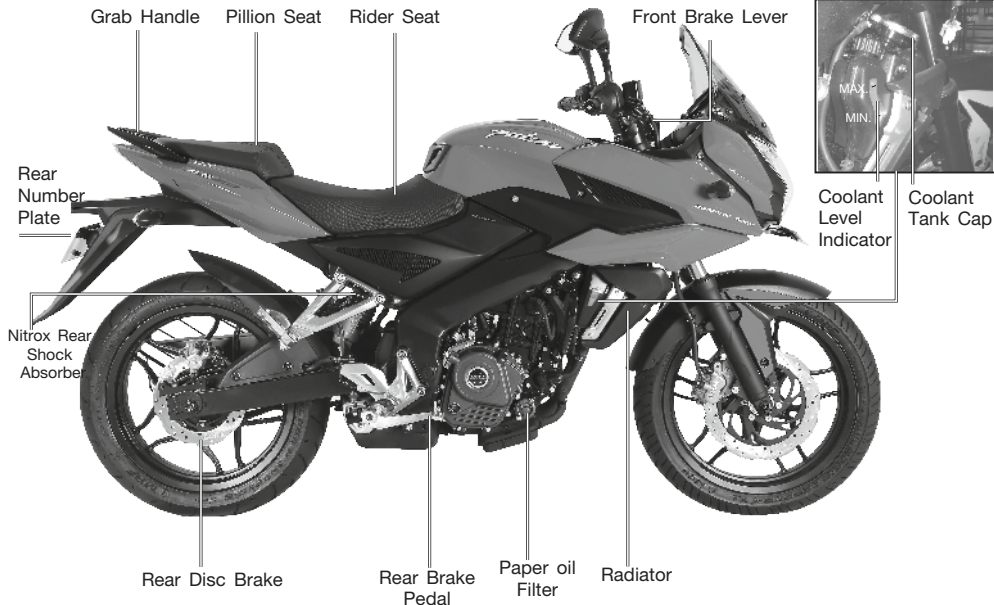







### Steering cum Ignition Lock :

It has three positions.

	<b>LOCK:</b> Steering locked. Ignition OFF.
	<b>OFF:</b> Steering unlock. Ignition OFF.
	<b>ON:</b> Steering unlock. Ignition ON.

**To Lock the Steering :** To lock the steering, turn the handle bar to the left side. Push & release the key. Turn the key to “LOCK” position and remove the key. **Steering lock can be done on left side only.**

**To Unlock the Steering :** To unlock steering, insert the key in steering cum ignition lock & turn it clockwise to “OFF” or “ON” position.

**Key :** A common key is used for ‘Steering cum Ignition lock’, ‘Fuel tank cap’ & ‘Rear Seat’.

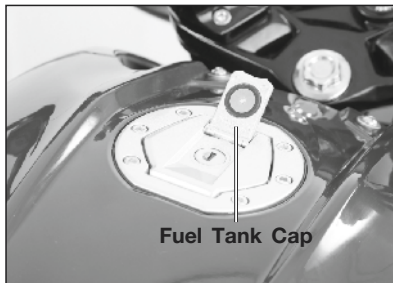



### Fuel Tank Cap

- To open the fuel tank cap, open the flap. Insert the key in the lock and turn it clockwise and lift fuel tank cap.
- 'Fuel Tank Cap' gets locked when pushed back into place.



### Fuel Tap

Fuel tap has following positions.

	ON : When fuel level is above Reserve position.
	RES: When fuel level is below Reserve position.
	OFF: When fuel supply is to be cut off.

## Speedometer Details



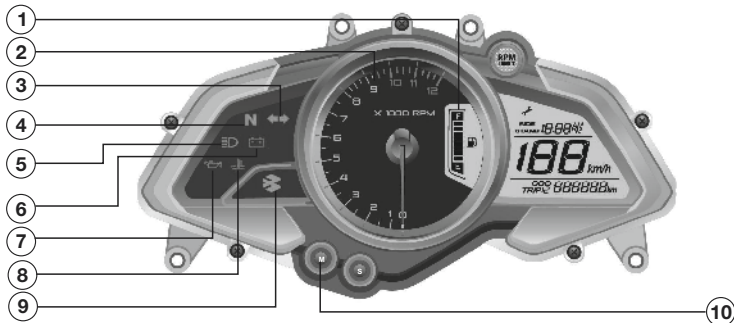

AS 200



Speedometer display will work when, only both Ignition switch & kill switch are in 'ON' position.

1. **Fuel Level Indicator:** It shows fuel level in fuel tank.
2. **Tachometer Dial:** It shows engine speed in RPM.
3. **Turn Signal Indicator (LH & RH):** When Turn signal switch is turned to Left or Right, Turn pilot Indicator - LH or RH will flash.
4. **Neutral Indicator:** When the transmission is in Neutral, Neutral indicator will glow.
5. **Hi Beam Indicator:** When Headlight is 'ON' & Hi beam is selected with engine running, Hi beam indicator will glow.

6. **Low Battery Indicator :** It indicates battery needs charging.
7. **Low Oil Pressure Indicator (  ) :** It blinks when engine oil pressure is low.
8. **Coolant Temperature Indicator (  ) :** It blinks when engine coolant Temperature is more than 115° centigrade.
9. **Bajaj Logo :** Bajaj logo flying 'B' continuously glows.
10. **Mode Button :** Mode button used for changing the mode while selecting & setting Trip1, Trip2, ODO, Clock & Service reminder.

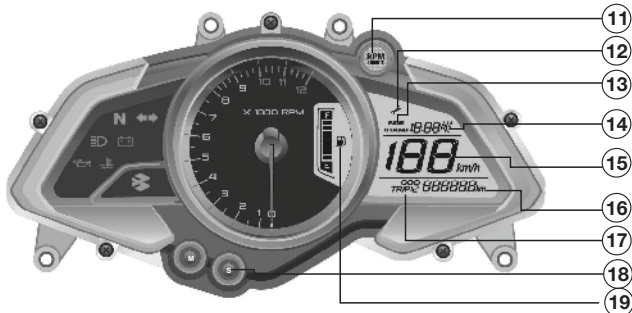

- 11. Engine Over Rev Indicator** : It glows when engine RPM crosses 9500 RPM.
- 12. Service Reminder (  )** : 'Spanner' symbol glows when ODO meter reading reaches set Kms. for service. This Icon will flash at -  
1<sup>st</sup> : 450 km      2<sup>nd</sup> : 4950 km,  
3<sup>rd</sup> : 9950 km,      4<sup>th</sup> : 14950 km  
and subsequently at each 5000 kms. Icon will continue to glow till it is reset. **This icon is to be reset after service is carried out.**
- 13. Side Stand Indicator** : When side stand is 'ON' . Side Stand Indicator will light.
- 14. Digital Clock** : It indicates **time in HR : M (AM/PM)**
- 15. Speedometer**: Vehicle speed will be displayed in digital form in Km / Hr.
- 16. Odometer** : The Odometer shows the total distance that the vehicle has covered. Odometer can't be reset to 'Zero'.
- 17. Trip Meter** : Trip 1 & Trip 2 shows the distance traveled since it was last reset to zero.
- 18. Set Button** : Set button used for setting Clock & Service reminder.
- 19 Reserve Indicator** : It blinks continuously when petrol level in tank reaches reserve level ( 1 bar or less)

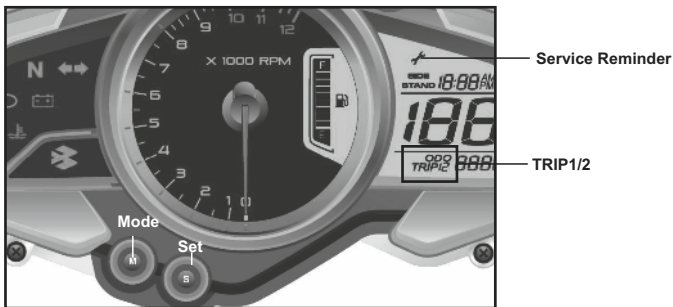

## 1. Trip Meter Reset :

- Mode & Set push button is provided for selecting & resetting 'ODO/TRIP1/TRIP2'. LHS part of speedo console.

1.	Press 'Mode' button for less than 2 sec.	Mode changes from 'ODO/TRIP1/TRIP2'
2.	Press 'Mode' button for more than 15 sec.	Selected mode 'TRIP1/TRIP2' will get reset. Other TRIP mode will continue updating.

## 2. Service Reminder Reset (🔧) :

- 'Wrench' symbol glows when ODO meter reading reached to set Kms.

This icon will glow at-

1<sup>st</sup> : 450 Kms      2<sup>nd</sup> : 4450 Kms

3<sup>rd</sup> : 9450 Kms      4<sup>th</sup> : 14450Kms

& subsequently at each 5000 Kms.

**Note :** Engine & motorcycle speed should be zero.

## Speedometer Setting



### 3. Clock Reset :

- Digital clock indicates time in HR & MM separated by colon ':'
- It is a 12 hour clock.
- Initially ':' will be blinking
- Clock setting is possible in TRIP 1 mode only.

1.	Press 'Mode' push button for less than 2 sec.	TRIP1 Mode selected
2.	Press 'Mode' & 'Set' push button together for more than 2 sec.	':' stops blinking Digits start blinking
3.	Press 'Mode' button for less than 1 sec.	Hour digits will increase by one.
4.	Press 'Set' button for less than 1 sec.	Minute digits will increase. If Mode/Set button is pressed continuously then digits will stop blinking.
5.	Press 'Mode' & 'Set' button together for more than 2 sec.	Set value will be saved Exit clock setting mode Digits stop blinking ':' start blinking
6.	Clock set 'Mode' is selected & no editing is carried out for more than 5 sec. <b>or</b> Vehicle is started.	Auto exit without saving set value.

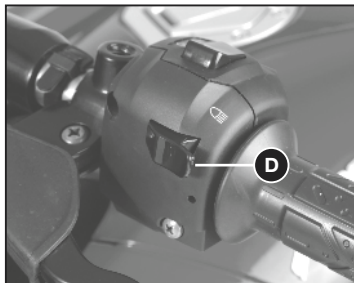
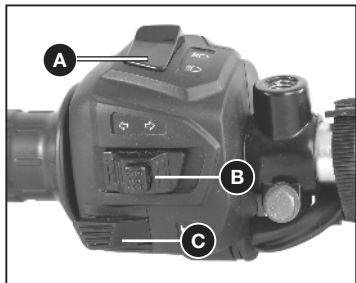

## Left Handle Bar Switches

**A. High/Low Switch :** When headlight is ON, High or Low beam can be selected with this switch. Hi beam indicator light located on Speedo console will light up when high beam is selected.

☰⊙ : High Beam      ⊙ : Low beam

**B. Turn Signal Switch :** When the turn signal knob is pushed to Left (↶) or Right (↷) respective indicator will start blinking, to exit push the knob in & release.

**C. Horn Button :** ( 📢 ) Press button for sounding horn.

**D. Pass Switch :** Press the switch to flash the head light. It is used to give signal to vehicles coming from opposite side while overtaking.

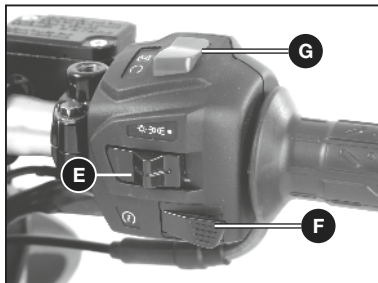

### Right Handle Bar Switches

**E. Head Light Switch :** It has 3 positions.

●	: All lamps 'OFF'.
☉	: With engine running, Tail lamp, Meter lamp and Pilot lamp/s 'ON'.
☀	: With engine running, Head lamp, Pilot lamp/s, Tail lamp and Meter lamps 'ON'.

### F. Starter Button :

Starter button operates the electric starter when clutch lever is depressed with transmission in any gear.

**It is recommended to start the engine with the transmission in neutral.**

### G. Engine Kill Switch :

The engine kill switch is for emergency use. During emergency move the engine kill switch to the 'OFF' (⊗) position.

Speedometer display will work when both Ignition switch & kill switch are in 'ON' position.



**CAUTION :** While starting ensure that engine kill switch is in ON (☉) position.

**Engine will not start if the kill switch is in OFF position**



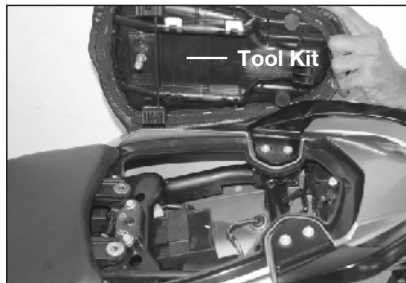
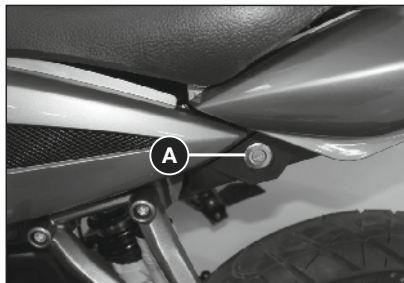

### Removal of Rear Seat

- Insert Key into lock (A)
- Turn the key clock wise.
- Pull front end of 'Rear seat'
- Take out 'Rear seat'

### Tool Kit Location

- It is located below the 'Rear seat'.
- 2 rubber straps are provided to hold the tool kit.

 **CAUTION** : Always ensure rubber strap is fitted for securing tool kit.

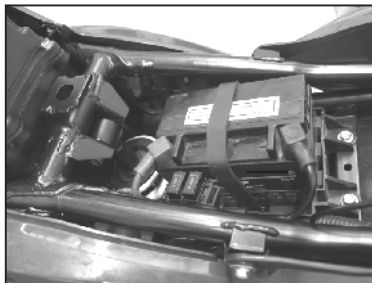
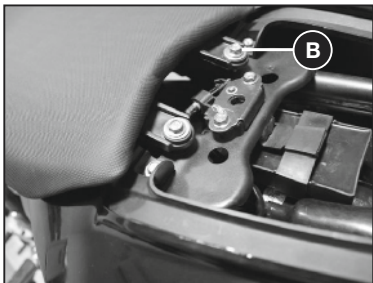

### Removal of Front Seat

- First remove 'Rear seat'.
- Remove 'Front seat' mounting bolts (B).
- Pull back rear end of 'Front seat'.
- Take out 'Front seat'.

### Battery

- It is located below 'Front seat'.

Battery details are given in 'Battery Maintenance' page no. 28.

### Front seat lug & bracket

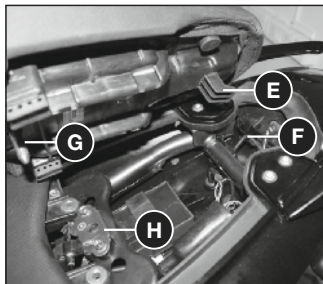
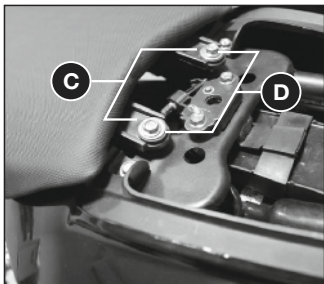
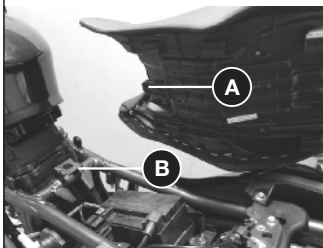

### Fitment of 'Front Seat'

- Match the lugs of 'Front seat' (A) with chassis bracket (B).
- Push 'Front seat' toward petrol tank.
- Match 'Front seat' rear brackets (C) with the holes provided on chassis.
- Tighten the bolts (D).

### Fitment of 'Rear Seat'

- First make sure 'Front seat' is fitted properly.
- Place 'Rear seat' in fitment location.
- Insert bracket (E) of seat into hook (F).
- Match the rod of 'Front seat' (G) with seat lock (H).
- Press front portion of seat.

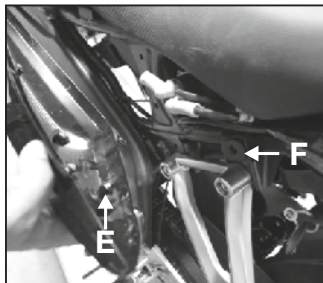
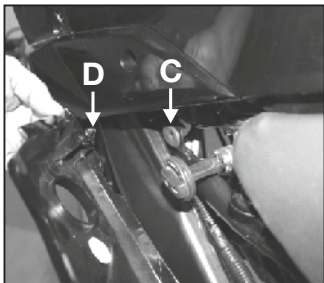
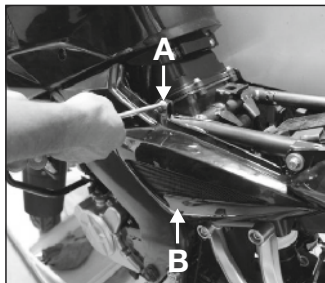

### Removal of Side Cover LH or RH

- Remove pillion & rider seat.
- Remove screw (A) upper & (B) lower of side cover mounting.
- Pull front portion of 'Side Cover' to release its lug from hole (C) provided on 'Fuel Tank'.
- Pull rear portion of 'Side Cover' to release its Lug (E) from hole (F) provided on 'Chassis'.

 **CAUTION** : Remove cover as described above, Otherwise the lugs may break.

### Fitment of Side Cover LH or RH

- Match Lug (D) provided on front portion of 'Side Cover' with hole (C) provided on 'Chassis' and press 'Side Cover' inside.
- Match Lug (E) provided on rear portion of 'Side Cover' with hole (F) provided on 'Chassis' and press 'Side Cover' inside.
- Tighten the upper (A) & lower (B) screw with screw driver.
- Fit pillion & rider seat.

 **CAUTION** : Fit cover as described above to ensure proper fitment.

## Daily Safety Checks



Before riding motorcycle be sure to check following items. Please give proper importance to these checks and perform all of them before riding motorcycle.

If any irregularities are found during these checks, refer to the Maintenance chapter & see your dealer for the action required to return the motorcycle to a safe operating condition.



**Warning :** Failure to perform these checks every day before you ride, may result in serious damage or severe accident.

- Enough **fuel** for planned distance of journey. No fuel leakage in fuel lines.
- **Engine oil** level (between upper and lower level mark)
- **Throttle cable** play of 2 ~ 3 mm. Smooth operation and positive return to closed position,
- **Brake Fluid** level above MIN mark provided on reservoir, applicable to disc brake vehicle.
- **Drive Chain** slack of 15 to 25 mm adequately lubricated.
- Function of all **lights & horn**
- **Clutch lever** play - 2 to 3 mm
- Check **Coolant** level between MIN and MAX mark in coolant reservoir tank.
- Smooth **steering movement** without restriction.
- **Side stand** return to its retracted position.
- Correct **inflation pressure** in both tyres  
Adequate tyre tread depth - no cracks / cuts.
- Correct **rear viewing** span adjustment of mirror.

## 1. Starting The Engine :

- Turn the fuel tap knob to 'U' or 'H' position.
- Turn ignition switch key to 'Q' position.
- Keep kill switch in 'O' position.
- Confirm that transmission is in neutral / press the clutch lever.
- If the engine is cold or when starting for first time, use manual choke (|↖|) for quick starting. Choke lever is located on LH side of carburettor.
- Keep throttle completely closed, press starter button,
- Release starter button as soon as engine starts.
- When the engine is warmed up enough to idle without using choke, return the manual choke to OFF position.

**Note :** Do not let the engine idle longer than 3 minutes otherwise it will overheat.

 **Caution :** Do not operate the starter continuously for more than 5 seconds otherwise battery would get discharged.

Wait 15 sec. between each operation of the starter which will facilitate battery to recover.

**Note :** The motorcycle is equipped with a starter lockout switch. This switch ensures that engine does not start if the transmission is in gear. However, the engine can be started in any gear if the clutch lever is pressed.

**Note :** In case of battery discharged condition, vehicle can be started by pushing it.

## 2. Shifting Gears :

- Close throttle & depress the clutch.
- Shift into next higher or lower gear.
- Open the throttle and release the clutch lever slowly and simultaneously.

## 3. Moving Off :

- Check that side stand is up / retracted.
- Depress the clutch lever.
- Shift into 1<sup>st</sup> gear.
- Open the throttle and release the clutch lever slowly and simultaneously.
- As the clutch starts to engage, open the throttle a little more, giving the engine just enough rpm to prevent it from stalling.

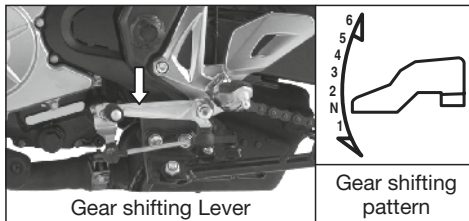

Gear shifting Lever

Gear shifting pattern

## Recommended Speed for Shifting Down

From 6 <sup>th</sup> to 5 <sup>th</sup> Gear	54 km/h
From 5 <sup>th</sup> to 4 <sup>th</sup> Gear	45 km/h
From 4 <sup>th</sup> to 3 <sup>rd</sup> Gear	35 km/h
From 3 <sup>rd</sup> to 2 <sup>nd</sup> Gear	25 km/h
From 2 <sup>nd</sup> to 1 <sup>st</sup> Gear	15 km/h

 **Warning :** When shifting down to lower gear, do not shift at such high speed that engine rpm jumps excessively. This may cause engine damage, & rear wheel may skid. Downshifting should be done at speeds as recommended in table above.

## 4. Braking :

- Close the throttle completely, leaving the clutch engaged (except where shifting gears) so that the engine braking will help slow down the motorcycle.
- Shift down one gear at a time so that you are in Neutral when you come to a complete stop.
- When stopping, always apply both brakes at the same time. De-clutch as necessary to avoid engine stalling.
- Never lock the brakes, or it will cause the tyres to skid. When cornering, use brakes judiciously and do not de-clutch. Reduce your speed before you get into the corner. For emergency braking, disregard downshifting, and concentrate on applying brakes as hard as possible without skidding.

## 5. Stopping the Vehicle :

- Close the throttle completely.
- Shift the transmission into neutral.
- Bring the vehicle to complete stop.
- Turn the ignition switch off.

## 6. Parking the Vehicle :

### 6.1 Parking using center stand.

- Center stand is available as accessories at dealership.
- Support the motorcycle on a firm level surface with the center stand.

### 6.2 Parking using side stand.

- Support the motorcycle on a firm level surface with the side stand.
- Lock the steering.



**CAUTION :** Do not park on a soft or steeply inclined surface or the motorcycle may fall over.

## 7. Running IN

Proper running-in is important for better life & trouble free performance of the vehicle.

- During first 2000 kms running-in period do not exceed following speed limits.

Kms	1st	2nd	3rd	4th	5th	6th
0 - 1000	10	18	24	32	40	48
1000 - 2000	16	24	30	38	46	54

- Always keep the speed below the limits mentioned in the table.
- Do not rev the engine excessively.
- Do not start moving or rev the engine immediately after starting. Run the engine for a minute at idle speed to give the oil a chance to workup into the engine.



### Fuel Saving Tips :

A well maintained vehicle and good driving can contribute a lot to the saving of fuel. Following are a few simple fuel saving tips.

### Good Riding Habits :

- Ride smoothly and steadily at a reasonable speed.
- Avoid harsh braking.
- Change the gear judiciously according to the speed and load requirement.
- Don't overload the vehicle above the specified payload.
- Use the accelerator judiciously.
- Cut off the engine if you want to stop for more than two minutes.

### How to check mileage (Fuel efficiency)

Best way to calculate mileage is by following the full tank to full tank method.

- Fill way tank full up to small mouth (brim).
- Run the bike for say 100 km.
- Fill the tank full again in same fuel filling station, preferably from same fuel dispenser.
- Divide kilometers run / fuel quantity filled.

Ensure following maintenance points to get optimum performance from your bike.

Fuel	Check fuel lines & connections for leakage.
Spark Plugs	Inspect and clean spark plugs. Adjust electrode gap. Replace spark plugs as per P.M. Chart.
Air Filter	Clean the air filter element periodically. Replace as per Periodic Maintenance Chart.
Engine Oil	Check engine oil level. Always use recommended grade and quantity.
Brakes	Ensure that the brakes are not dragging / binding.
Clutch	Ensure correct clutch lever play.
Tyre Air Pressure	Always maintain recommended tyre pressure.
Carburettor	Clean & adjust the carburettor. Adjust idling speed.

### Safe Riding Tips

- Always wear Helmet while riding. Your helmet should conform to appropriate Safety standards.
- Thoroughly read the instructions given in this manual and follow them carefully.
- Avoid unnecessary accessories for the safety of both rider and other motorists.
- Get familiar with and follow traffic rules & regulations in your states as well as general traffic signs.
- Familiarise yourself well with starting, acceleration and braking of the vehicle.
- When applying the brakes, use both front & rear brakes simultaneously. Applying only one brake may cause the rider to lose control.
- Riding at proper speed and avoiding unnecessary acceleration and braking are important not only for safety and low fuel consumption, but also for long life of the vehicle.
- During monsoon drive the vehicle more cautiously. Remember vehicles skid more easily during light showers.



- Drive cautiously. Start early & reach your destination safely.
- Always carry vehicle registration & insurance papers, and a valid driving licence with you.
- Avoid driving on loose sand or stones where vehicle is likely to skid.
- Properly wrap-up loose clothes while riding to avoid entangling in wheel or other objects on road.
- Always concentrate on Safe riding.

### Rainy Season Care :

- It is suggested to customer to take appropriate care in area of high rainfall area. Appropriate surface preventive coat to avoid rusting on account of adverse atmospheric conditions.
- Vehicle cleaning to be done with soft & clean wet cloth to avoid scratches on painted parts.
- Clean & lubricate all the important parts as detailed in a periodic maintenance chart.
- Do not apply direct water jet on painted, electrical / electronic parts.
- Do not obstruct engine cooling by adding mud protection sheet from front.

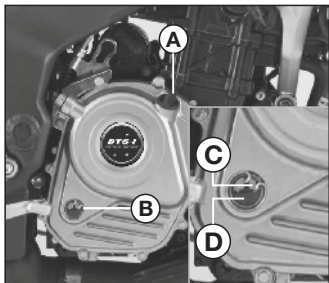

- A : Oil Filler Cap**
- B : Oil Level Window**

## Engine Oil Level Checking :

- Check engine oil level every day in the morning. Park vehicle perpendicular to the ground on level surface as mentioned in page no. 21 (6.1)
- Check oil level through oil level window 'B'.
- Always maintain engine oil level between upper (C) and lower (D) mark provided on Clutch cover RHS. Top up with specified grade of oil, if the oil level is below lower level mark.

## Engine Oil Capacity :

- Refill at servicing : 1200 ml.
- During engine overhaul : 1400 ml.

## Recommended Engine Oil:

Model	Recommended Engine oil Grade
Pulsar 200 NS/AS	SAE 20W50 API 'SL', or JASO 'MA'

- Engine oil replacement frequency : 1<sup>st</sup> service & then every 5,000 Km.
- Engine oil level top-up frequency : Every 2500 km.



## CAUTION :

- It is most important to adhere to recommended grade & frequency of oil change for the purpose of long life of critical engine components. For details refer periodic maintenance chart.
- Do not reuse drained oil.
- Contact your Dealer for proper disposal of drained engine oil.



**Front Wheel**



**CAUTION :** Tubeless tyres are fitted in this motorcycle. The walls of the tyres in contact with the wheel rim should not be damaged in any way during fitment / removal of tyre. The tyre side walls in contact with wheel rim seals air.

### Removing Front Wheel :

- Park vehicle perpendicular to the ground on level surface as mentioned in page no. 21 (6.1)
- Remove speed sensor cable from case meter assembly.
- Loosen front axle nut.
- Remove front wheel assembly from fork.

### Wheel Puncture :

- Visit nearest known tubeless tyre repair shop to remove puncture.
- Remove puncture by Filler or Plug method only.
- Do not use patch method to remove puncture of tubeless tyre.

### Tyre Pressure :

Keep appropriate tyre pressure as mentioned below to increase life of the tyre & for better fuel consumption.

Pulsar 200 NS/AS	Front	25 PSI
	Rear (Solo)	28 PSI
	Rear (with Pillion)	32 PSI

**Note :** *Ensure tyres fitted comply with local rules and regulations governing tyres.*



### Battery : 12V - 8 Ah VRLA

- Battery is located below front seat.

#### Battery Features :

- No topping-up is required
- Reduced self discharge, Enhances safety.
- No vent tube open to atmosphere hence no discharge of electrolyte through vent tube.

 **CAUTION :** Do not drive / run vehicle in battery disconnected condition. It may lead to damage of electrical / electronic components.

- Environment care must be taken to dispose off the used battery.

- It is always recommended to hand over the same to an Authorised battery / Bajaj dealer for proper disposal.
- When low battery icon pops-up on speedometer display, it is advised to get in touch with Bajaj dealer & get it charged immediately.

#### How to keep battery healthy ?

- Switch 'Off' ignition when engine is not running.
- Get battery checked/ charged during periodic services.
- Do not press starter button for more than 5 sec. After 3 successive cranking, wait for 15-20 sec. for battery to recover.
- **Do not add extra electrical accessories such as - Remote, Bigger Horn, Musical brake light etc. This will reduce life of battery**
- Disconnect battery +ve & -ve wires if vehicle is to be stored for more than 2 weeks. This avoids self discharge.

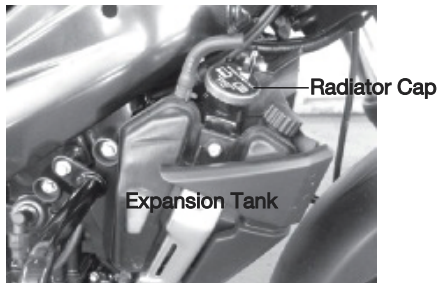
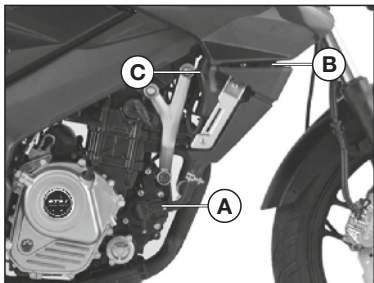

- Coolant is provided for cooling of engine.
- Water pump (A) in the engine circulates the coolant in cooling system.
- The pressure resulting from the heating of the cooling system is regulated by a valve in radiator cap (B).
- Heat expansion causes excess coolant to flow into compensating coolant tank (C).
- When the temperature falls, this surplus coolant is sucked back into the cooling system.



**Warning :** During motorcycle operation, the coolant gets very hot & is under pressure.

Do not remove the radiator cap, radiator hose or other cooling system components when the engine is hot.

Allow the engine & cooling system to cool down. In case of exposure to hot coolant, rinse immediately with lukewarm water.

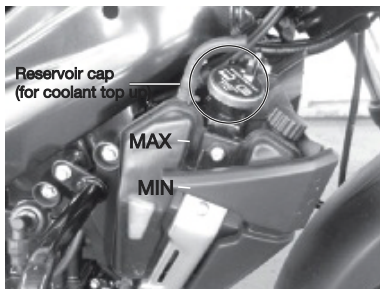

**Warning** : Coolant is poisonous and is a health hazard.

Avoid skin, eye and clothing contact with coolant. If it gets into your eyes, rinse immediately with water and contact a doctor.

**Wash affected skin areas immediately with soap and water. If coolant is swallowed, contact a doctor immediately. Change clothes that have come into contact with coolants. Keep coolant out of the reach of children**

### Coolant Specifications :

Antifreeze ready mix (Recommended Brand-  
Motul : Moto cool expert,  
Castrol : Radicool

Total coolant quantity : 1000 ml. (750~780 ml in radiator & 220~230 ml expansion tank).

### Coolant Top up

- Park vehicle perpendicular to the ground on level surface as mentioned in page no. 21 (6.1)
- Check coolant level in engine cold condition only.
- Ensure coolant level is between Min & Max mark.
- Always top up coolant through reservoir cap.
- Always replace coolant with recommended brand only. (Radicool from Castrol, Moto cool expert from Motul) or equivalent.
- Use nitrile rubber hand gloves while draining & topping up coolant.
- Do not top up coolant through radiator cap. Where pre-mixed coolant is not available coolant concentrate and distilled water should be mixed separately in a clean jar in a proportion of 1:1

## Spark Plug

- Remove spark plugs by using plug spanner.
- Clean the spark plugs.
- Adjust the gaps if incorrect by bending outer electrode carefully.

**Spark Plug Gap** : 0.7 to 0.8 mm.

**Spark Plug** (2 Nos.) : RG-6HCC  
(LH 'A' + RH 'B')  
(1 No. ) : BOSCH - VR5NE  
(Center 'C')

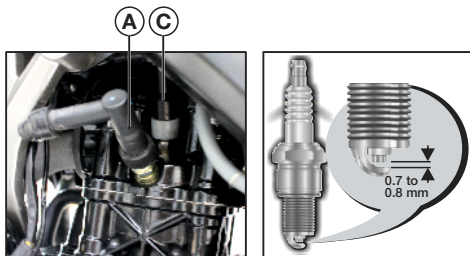

## Drive Chain Slackness

- Chain slackness will have to be adjusted whenever required.
- Std. Chain slackness 15 ~ 25 mm.
- Marking on chain adjusters should be identically positioned on both sides.

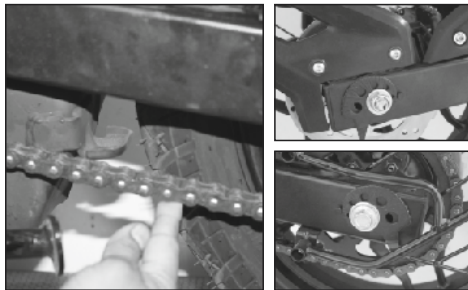



### Drive Chain Cleaning

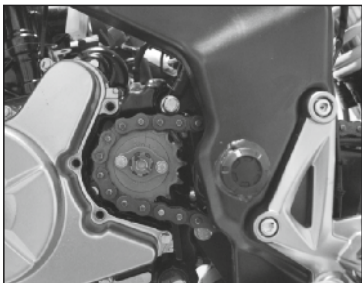

Drive chain must be cleaned & lubricated as per periodic maintenance schedule.

### Drive Chain (O-ring type)

- 'O' rings must always be kept wet for best performance hence lubricate every 500 Km.
- **O-ring chain lubrication can easily be done by owners using Bajaj 'Chain Lube Spray Can' available with Bajaj dealers, or equivalent. Ensure that the lubricant does not damage the rubber 'O' rings.**



### Drive Chain Lubrication

### Method of O-ring Chain Lubrication :

- Park vehicle perpendicular to the ground on level surface as mentioned in page no. 21 (6.1). Clean the chain by using lint free cloth (If excessive mud / slush found approach Bajaj Service Center for proper cleaning)
- Shake the can vigorously by holding vertically upright till the noise of steel ball inside heard uniformly.
- Hold spray can at the back of rear sprocket with extension tube nose at 5~10 cm.
- Rotate the wheel in reverse direction & spray the lube on middle portion of the chain up to full length of the chain.

**Front  
Brake  
Fluid  
Reservior**

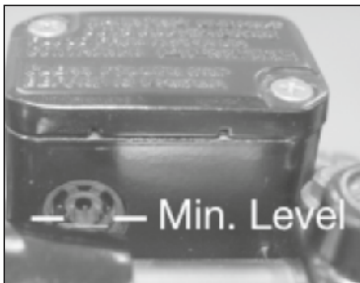

**Rear  
Brake  
Fluid  
Reservior**

### Front & Rear Brake Fluid Level

- Front brake fluid reservoir is located on RH side of Handle bar.
- Rear brake fluid reservoir is located behind RH pillion holder bracket.
- To check oil level, Park vehicle perpendicular to the ground on level surface as mentioned in page no. 21 (6.1) with handle bar in straight ahead condition
- Always ensure that brake fluid level is above 'MIN' mark given on inspection Window.

### Brake Fluid Replacement

- Check & Adjust brake fluid level in every service.
- Change the brake fluid of the front & rear brake according to service schedule.

Use only DOT-3 or DOT-4 brake fluid (from sealed container) for top up & replacement.

# Periodic Maintenance & Lubrication Chart



Sr. No.	Operation	RECOMMENDED FREQUENCY								Remarks
		Servicing	1st	2nd	3rd	4th	5th	6th	7th	
		Kms	500 750	4500 5000	9500 10000	14500 15000	19500 20000	24500 25000	29500 30000	
1	Clean the vehicle with water wash & dry completely		✓	✓	✓	✓	✓	✓	✓	Ensure to prevent water entry in Petrol tank, Silencer & electrical parts. Use caustic free detergent for washing.
2	Engine oil & engine oil filter*	C,R	R	R	R	R	R	R	R	<b>SAE 20W50 "API SJ" Grade</b> Replace at every 5000kms. And top-up at every 2500 Kms (If required)..
3	Oil strainer	CL	CL		CL		CL		CL	Oil strainer cleaning at the time of oil change.
4	Spark plug	CL,C,R					CL,A		R	
5	Air cleaner element*** & cover 'O' ring	R				R			R	
6	In line Paper filter or Fuel Cock paper filter	R				R			R	
7	Fuel cock sediment bowl cleaning	CL				CL			CL	
8	Carburetor rubber duct	C,R					C,R			
9	Fuel pipe	C,R	C	C	C	R	C	C	R	
10	Valve tappet clearance	C,A				C,A			C,A	

# Periodic Maintenance & Lubrication Chart



Sr. No.	Operation	RECOMMENDED FREQUENCY								Remarks
		Servicing	1st	2nd	3rd	4th	5th	6th	7th	
		Kms	500 750	4500 5000	9500 10000	14500 15000	19500 20000	24500 25000	29500 30000	
11	Sealed drive chain cleaning & lubrication	CL,L,A	CL,L A	CL,L A	CL,L A	CL,L A	CL,L A	CL,L A	CL,L A	(Customer to apply OKS chain lube spray at every 500 kms)
12	Engine air breather tube	C,R				C,R			C,R	Check & replace if required
13	Brake cam & brake pedal pivot pin	C,L,R	C	C,L,R	C,L,R	C,L,R	C,L,R	C,L,R	C,L,R	Use recommended AP grease.
14	Brake lining or pad -Check wear indicator	C,R	C,R	C,R	C,R	R	C,R	C,R	R	Replace brake shoes /brake pad at every15000 Kms
15	Brake fluid level ** - top up / replace	C,A,R				C,A			R	Use recommended brake fluid (DOT3/DOT4).
16	Disc brake assly -- Check functionality, leakage or any other damage.	C			C		C		C	Replace if damaged
17	All cables & rear brake pedal -free play	C,A	C,A	C,A	C,A	C,A	C,A	C,A	C,A	
18	Wiring harness & Battery connections- routing, tie bands & clamps tightness.	C,A,T	C,A,T	C,A,T	C,A,T	C,A,T	C,A,T	C,A,T	C,A,T	
19	Ignition switch barrel cleaning & handle bar control switches contacts cleaning,	C,CL	C,CL	C,CL	C,CL	C,CL	C,CL	C,CL	C,CL	Use recommended WD40 spray

# Periodic Maintenance & Lubrication Chart



Sr. No.	Operation	RECOMMENDED FREQUENCY								Remarks
		Servicing	1st	2nd	3rd	4th	5th	6th	7th	
		Kms	500 750	4500 5000	9500 10000	14500 15000	19500 20000	24500 25000	29500 30000	
20	Steering play	C,A	C,A	C,A	C,A	C,A	C,A	C,A	C,A	
21	Steering stem bearing*** & Cap steering bearing(Plastic)**	C,CL L,R			C,CL L,R		C,CL L,R		C,CL L,R	Check & replace if damaged. Use HP Lithon RR3 grease for lubrication.
22	Main stand & side stand pin**	CL,L			CL,L		CL,L		CL,L	Use recommended AP grease.
23	All fasteners tightness	C,T	C,T	C,T	C,T	C,T	C,T	C,T	C,T	
24	Engine foundation silent bushes **	C				C			C	
25	General lubrication-Clutch lever, front brake lever.	L	L	L	L	L	L	L	L	Use recommended AP grease.
26	Idle speed / CO%	C,A	C,A	C,A	C,A	C,A	C,A	C,A	C,A	
27	Coolant level in expansion tank	C,A	C,A	C,A	C,A	C,A	C,A	C,A	C,A	Use recommended 'Ready to use coolant'.
28	Coolant hose damage/clamps/leakage	C		C	C	C	C	C	C	

## Periodic Maintenance & Lubrication Chart



Sr. No.	Operation	Servicing	RECOMMENDED FREQUENCY							Remarks
			1st	2nd	3rd	4th	5th	6th	7th	
			Kms	Kms	Kms	Kms	Kms	Kms	Kms	
29	Radiator fins	C,T	C,T	C,T	C,T	C,T	C,T	C,T	C,T	

\* It is strongly recommended to use specified grade only , In case of any other engine oil of same specifications is used the frequency would be every 5000 kms

\*\* As applicable to model

\*\*\* More frequent cleaning is required while driving in dusty environment.

**C : Check, A : Adjust, CL : Clean, R : Replace, T : Tighten, L : Lubricate**

**Note:** periodic parts / lubricants as per periodic maintenance & chart are mandatory & the same is chargeable to customer.

## Non-Use Maintenance



Non-use maintenance is necessary if a vehicle remains off road for a longer duration (more than 15 days\*\*). The correct and careful non-use maintenance carried out before storing the vehicle will prevent the vehicle from rusting and from such other non-operational damages like fire hazards.

- Clean the entire vehicle thoroughly.
- Empty the fuel from the fuel tank and carburettor float bowl (if fuel is left in for a longer time, the fuel will break and gummy substance could clog the carburettor).
- Remove spark plug & put several drops of engine oil into the cylinder. Kick engine over slowly a few times to coat cylinder wall with oil & install spark plug.
- Set the vehicle on a box or a stand so that both wheels are raised off the ground.
- Spray oil on all unpainted metal surfaces to prevent rusting. Avoid getting oil on rubber parts or brake liners.
- Cover entire vehicle neatly. Make sure that storage area is well ventilated & free from any source of flames or spark.

- Fill 10% excess air pressure in both wheels.
- Do not apply oil on front brake disc, to prevent rusting. If the front brake disc rusts during storage, do not attempt to clean it with soap water. The rust will go off automatically during first few application of brake.

### \*\* For Battery :

- a. Remove battery and keep it on wooden plank, in properly ventilated area.
- b. Before taking the vehicle for use.
  - Get the battery recharged from the Authorised Service Center / Battery Dealer.
  - Apply petroleum jelly on terminals. (applicable to certain models).

### Preparation for regular use after storage :

- Clean the vehicle
- Fit the battery after recharging.
- Make sure the spark plug is tight.
- Fill the fuel tank with fuel.
- Change the engine oil.
- Check all the points listed in the Daily Safety Checks section.
- Check and inflate tyres to proper tyre pressure.